

N-type male connectors

Suits RG & RU cables

Page 1 of 2



In-stock
Ready to
Ship
* Signifies build to
order item

7913

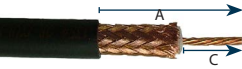

N-type male solder pin clamp connector
For RG213 cable

Tri-metal plated
Low P.I.M.



A = 8.5 mm
C = 4.0 mm

7917



N-type male solder pin clamp connector
For RG58 cable

Nickel plated

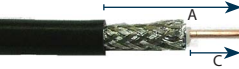

A = 7.0 mm
C = 4.0 mm

7917-2*



N-type male solder pin clamp connector
For RG58 cable

BLACK
Nickel plated

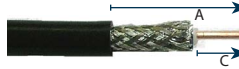

A = 7.0 mm
C = 4.0 mm

7923-4



N-type male solder pin crimp connector
For RG59 cable

Tri-metal plated
Low P.I.M.

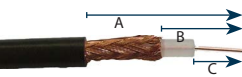

A = 14.2 mm
B = 6.7 mm
C = 3.5 mm

7930



N-type male solder pin crimp connector
For RU400/RG8 cable

Nickel plated

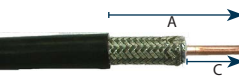

A = 12.0 mm
C = 7.0 mm

7930-4



N-type male solderless clamp connector
For RU400/RG8 cable

Nickel plated



Fitting Instructions are supplied

7932-4



Right-angle N-type male solder pin crimp connector
For RG214 cable

Tri-metal plated
Low P.I.M.

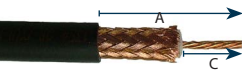

A = 20.0 mm
C = 5.0 mm

7933-2



N-type male crimp connector
For RG58 cable

Tri-metal plated
Low P.I.M.

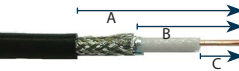

A = 14.2 mm
B = 6.7 mm
C = 3.5 mm

7933-3



N-type male crimp connector
For RG58 cable

Nickel plated

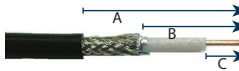

A = 14.2 mm
B = 6.7 mm
C = 3.5 mm

7937



N-type male solder pin crimp connector
For RG213 cable

Tri-metal plated
Low P.I.M.



A = 15.4 mm
B = 7.9 mm
C = 4.0 mm

7937-2



N-type male solder pin crimp connector
For RG214 cable

Tri-metal plated
Low P.I.M.



A = 15.4 mm
B = 7.9 mm
C = 4.0 mm

7925



N-type cable termination screw mount

N-type male connectors

Suits RG & RU cables

Page 2 of 2



In-stock
Ready to
Ship
* Signifies build to
order item

8200

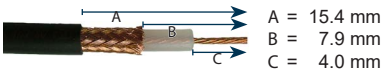

N-type male
crimp connector
For RG142 cable

Tri-metal plated
Low P.I.M.



8201



Right-angle
N-type male
solder pin crimp
connector
For RG142 cable

Tri-metal plated
Low P.I.M.

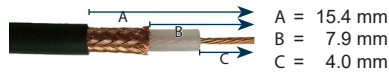

8217



N-type male
solder pin square
flange connector
4 hole attachment

Nickel plated

8217-2



N-type male
solder pin flange
connector
4 hole attachment

Nickel plated

8219



Right-angle
N-type male
solder pin clamp
connector
For RG58 cable



8226



N-type male
solder pin crimp
connector
For RU400/RG8 cable

Tri-metal plated
Low P.I.M.

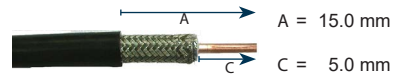

8226-2



N-type male
solder pin crimp
connector
For RU600/LMR600
cable

Tri-metal plated
Low P.I.M.

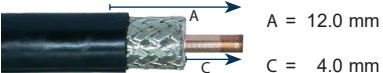

8226-3



N-type male clamp
connector
For RU600/LMR600
cable

Tri-metal plated
Low P.I.M.

Fitting Instructions
are supplied with
connector

8266



N-type male 75 Ohm
solderless clamp
connector
RU400-75 cable

Tri-metal plated
Low P.I.M.



8266-2*



Right-angle N-type
male
solder pin clamp
connector
For RG213/RU400/RG8
cable

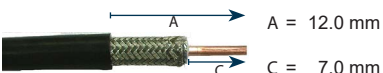

8266-3



Right-angle N-type
male
solder pin crimp
connector
For RG213/RU400/RG8
cable

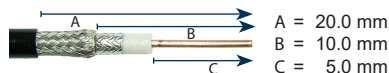

8278



N-type male
solder pin crimp
connector
For RG174/RG316 cable

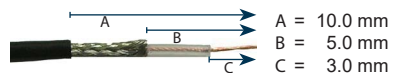

8283



N-type male
solder pin crimp
connector
For RG223/RG142 cable

Nickel plated



8286



Right-angle
N-type male
solder pin crimp
connector
For RU400/RG8 cable

Tri-metal plated
Low P.I.M.

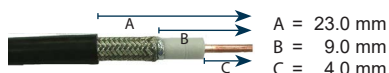

8303*



N-type male
solder pin crimp
connector
For RG142 cable

